

Assembly Instructions

Wall-Mounted Jorgenson Signature Lockers with Coat Rod

1

Identify Parts

Remove unassembled locker parts from the packaging. Next, locate and identify each part based on the images show below:

TIP: Tip: Ensure that the bolts are installed on the outside of locker and nuts are secured on the inside of the locker.

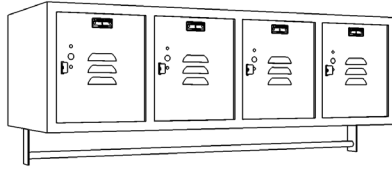

(1) Wall Mounted Top

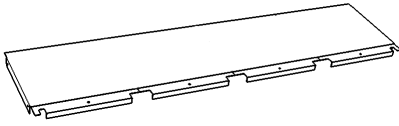

(1) 4-Wide Front Door

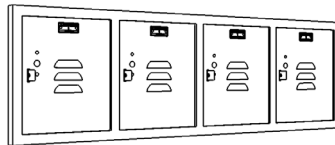

(3) Dividers

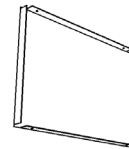

(1) Wall Mounted Bottom
No Holes in Front Flange

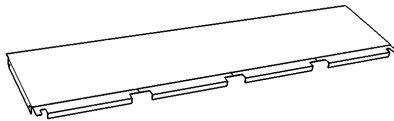

(1) Wall Mounted Back

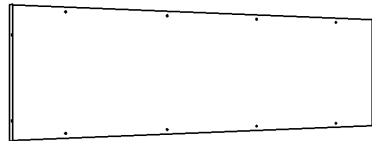

(2) Coat Rod
Brackets

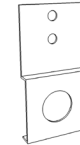

(2) Wall Mounted
Sides

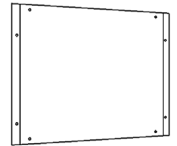

(1) Coat Rod



(2) Push-in
Thread Washers



(2) Coat Rod
Retaining Brackets

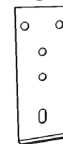

(2) Hanging Plates

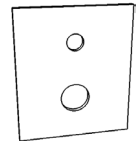

2

Start Assembling

- Position the back panel on straight, even flooring or pair of saw horses.
- Gently bolt the top and bottom panels to the inside of the back panel.
- Bolt the 3 dividers to the top and bottom panels.

Bolt the tamper-proof screw on the inside of the locker. Only the screw heads should be visible from the outside of the locker.

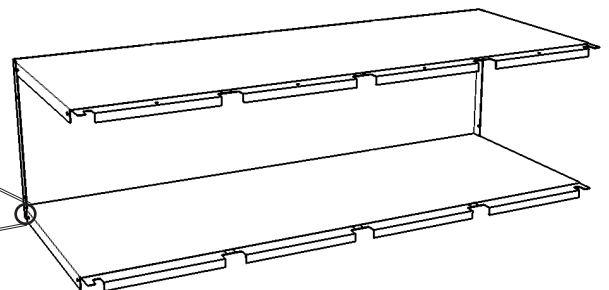
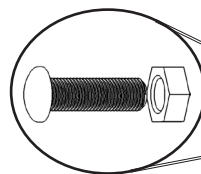

Assembly Instructions

Wall-Mounted Jorgenson Signature Lockers with Coat Rod

3

Continued Assembly

- Slightly bolt the dividers and side panels to the top, bottom, and back panels.

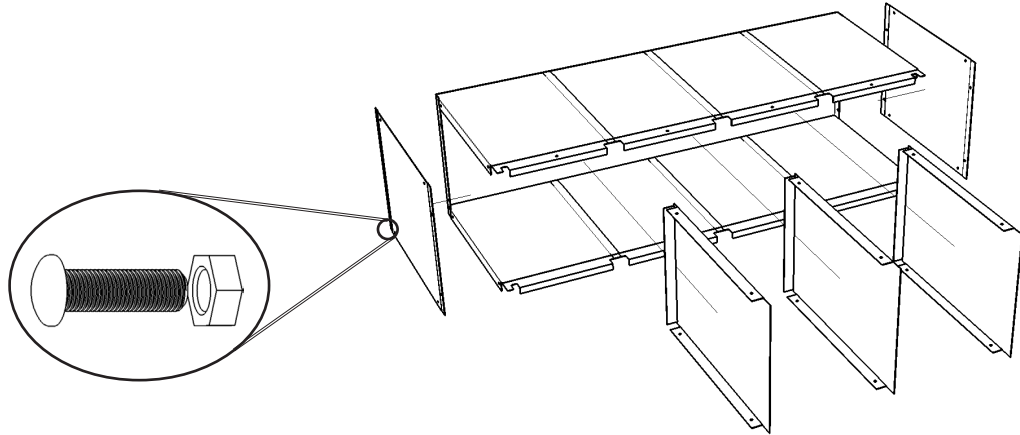

4

Insert Front Door Frame

- After the top and bottom panels have been attached, proceed to insert the door frame on the outside of the left, right and bottom panels.

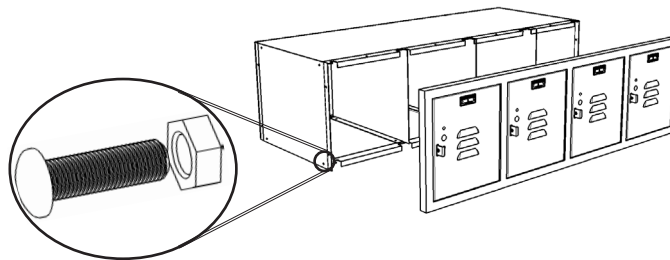

5

Assemble the coat Rod

- Bolt coat rod retaining brackets to locker sides
- Insert push-in thread washers about 3/4" deep into each end of the coat rod
- Slide coat rod brackets onto coat rod and bolt them to the coat rod retaining brackets
- Put 1 bolt on each side through the holes in the coat rod retaining bracket and coat rod bracket into the push-in thread washer

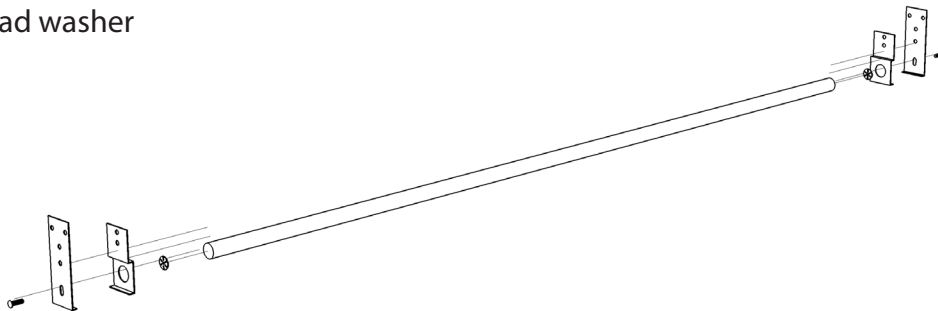

Assembly Instructions

Wall-Mounted Jorgenson Signature Lockers with Coat Rod

6

Final Assembly

- Anchor locker to wall using hanging plate and ensure that locker is level.
- When locker is level, test the door to determine it opens properly. Bolts can be adjusted if there are any problems with opening and closing.
- Once the door is functioning correctly, tighten all bolts.

