

Assembly Instructions

Jorgenson Kids Sports Locker

1

Identify Parts

Remove unassembled locker parts from the packaging. Next, locate and identify each part based on the images show below:

TIP: Tip: Ensure that the bolts are installed on the outside of locker and nuts are secured on the inside of the locker.

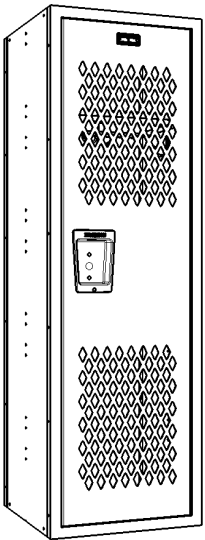

(1) Front Door (1) Back Panel (2) Side Panels

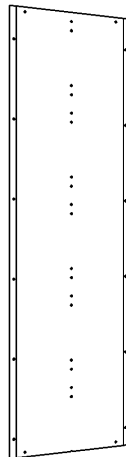
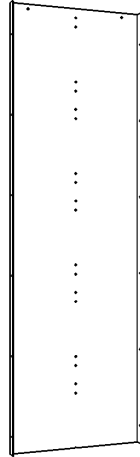
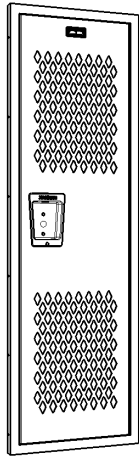

(2) Top/Bottom Panels

Top/Bottom are identical

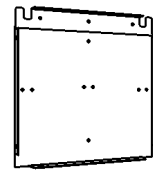

(1) Hat Shelf

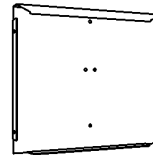

2

Start Assembling

- Position the back panel on straight, even flooring or pair of saw horses.
- Gently bolt the left and right side panel to the inside of each back panel

Bolt the tamper-proof screw on the inside of the locker. Only the screw heads should be visible from the outside of the locker.

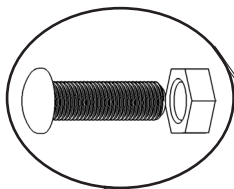

Top holes are 1/2" at the top of each panel shown.

View of locker with back panel flat on floor or saw horses

The left and right side panels must be placed inside the back panel flanges.

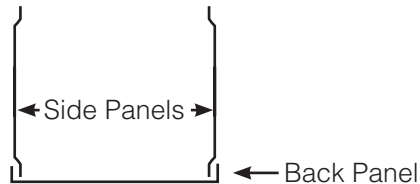

Left Side Panel

Right Side Panel

Assembly Instructions

Jorgenson Kids Sports Locker

3

Continued Assembly

- Slightly bolt the top panel, hat shelf, and bottom panel inside the side and back panel.

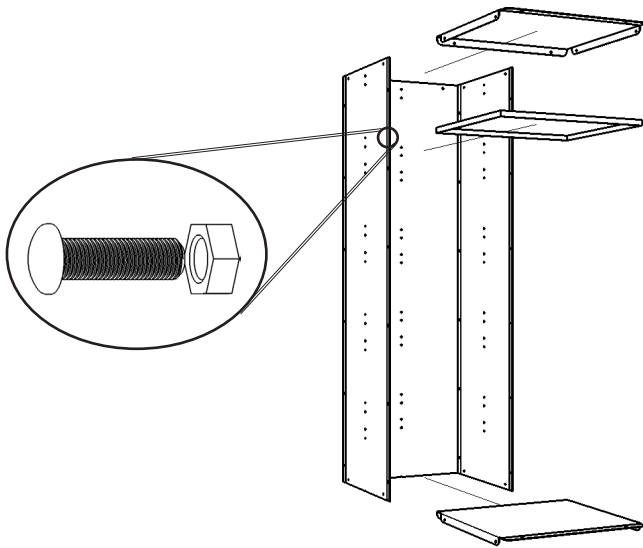

Note:

Top and bottom panels have two (2) round, pre-drilled holes that can be found on the back flange and are designed to bolt to the back panel.

4

Insert Front Door Frame

- After the top and bottom panels have been attached, proceed to insert the door frame on the outside of the left, right and bottom panels.

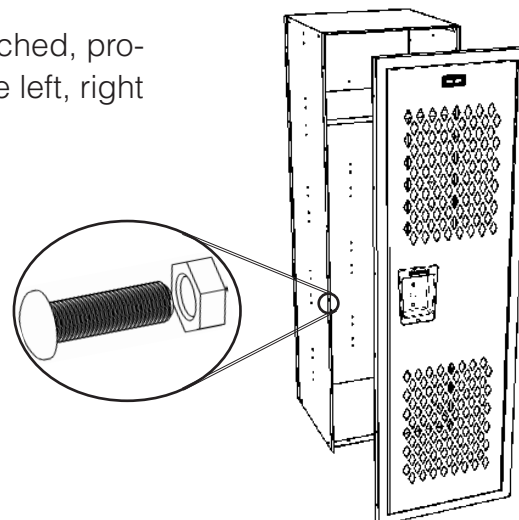

Assembly Instructions

Jorgenson Kids Sports Locker

• 5 •

Insert Front Door Frame

- Place locker in the upright position and make sure locker is level.
- When locker is level, test the door to determine it opens properly. Bolts can be adjusted if there are any problems with opening and closing.
- Once the door is functioning correctly, tighten all bolts.
- To instill proper safety measures, we highly advise anchoring the locker to the floor or wall to avoid injury or theft.

